



Classic Collection (CS-10)

- Powder Coated Black
- Ductile Iron
- 6 Feet Long
- Surface Mount

Benches - Backed

Auburn Streetscape - 90% Progress Meeting

June 14, 2017

© 2017 JPR - All Rights Reserved



JONES PETRIE RAFINSKI
your one single source
Surveying • Engineering • Planning • Architecture • Utility Management
GIS • Environmental • Renewable Energy • Landscape Architecture



Classic Collection (CR-298)

- Powder Coated Black
- Ductile Iron
- 6 Feet Long
- Surface Mount



Benches - Backless

Auburn Streetscape - 90% Progress Meeting

June 14, 2017

© 2017 JPR - All Rights Reserved



JONES PETRIE RAFINSKI
your one single source

Surveying • Engineering • Planning • Architecture • Utility Management
GIS • Environmental • Renewable Energy • Landscape Architecture

BIKE RACK PROVIDED BY ROTARY CLUB

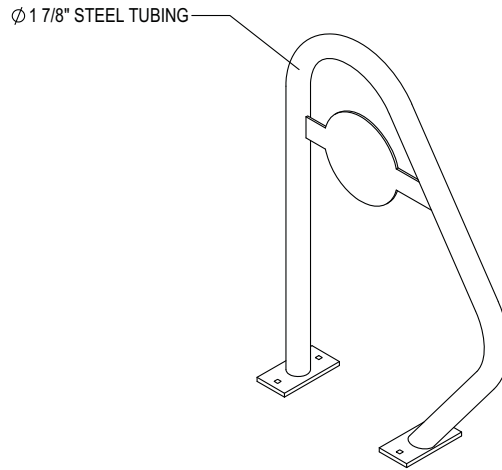
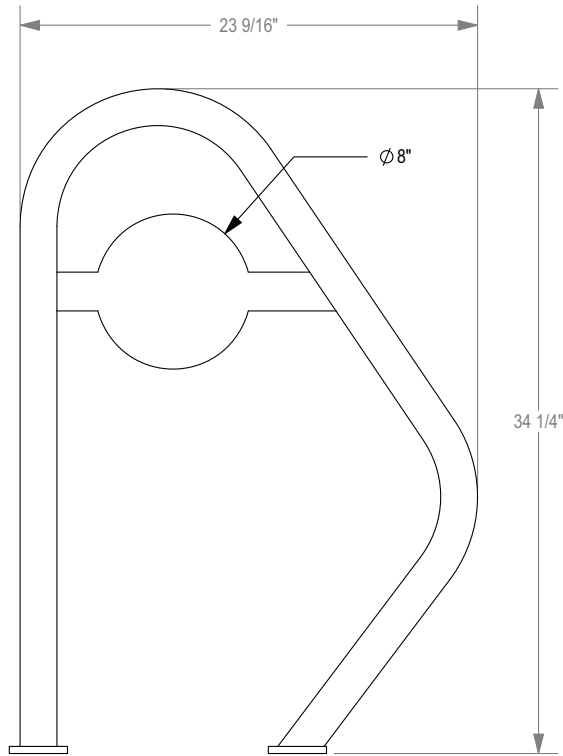

CHECK DESIRED MOUNT

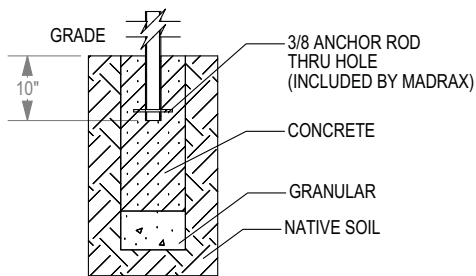

IN GROUND MOUNT (IG)

SECTION VIEWS

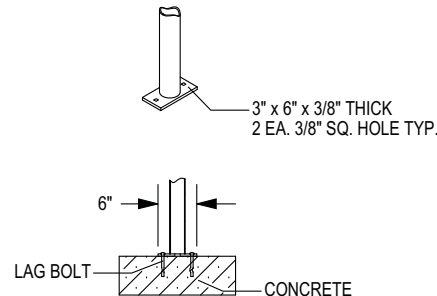

SURFACE FLANGE MOUNT (SF)

Madrax Phoenix Bike Rack

- PHX-SNG-ROTARY
- Powder Coated Steel
- Includes Decal
- Height: 34.25 in.

Bike Racks

Auburn Streetscape - 90% Progress Meeting

June 14, 2017

© 2017 JPR - All Rights Reserved



JONES PETRIE RAFINSKI
your one single source

Surveying • Engineering • Planning • Architecture • Utility Management
GIS • Environmental • Renewable Energy • Landscape Architecture

KEYSTONE RIDGE

The **HARBOR STRAIGHT BOLLARD** adds a subtle design touch to public space management, providing security as a vehicle deterrent. Add chain loops to direct the flow of pedestrian traffic or swap in larger loops for bicycle mountings.



STANDARD FEATURES

- Color: exclusive KEYSHIELD® polyester powder coating finish
- Support: permanent or removable
- Top: rounded or angled
- Fully assembled unit
- Continuous weld seams
- Three-year warranty
- Made in the USA

CUSTOM OPTIONS

- Color: custom KEYSHIELD® powder coat
- Support: surface mount

ENHANCEMENTS

- Inquire about coordinating benches, litter receptacles, planters, tables, and other furnishings
- Cast bronze plaques



Harbor Straight Bollard

- Powder Coated Black
- Angled Top
- Weight: 100 lbs.
- Height: 37 in.

Bollards

STERNBERG VINTAGE LIGHTING (E460LED/FA/56 | 6P5/2 | L45T3/MDL | 4/2-DBA/(2)GFILP-IUC/SH(.5)/DHPA/BKT)

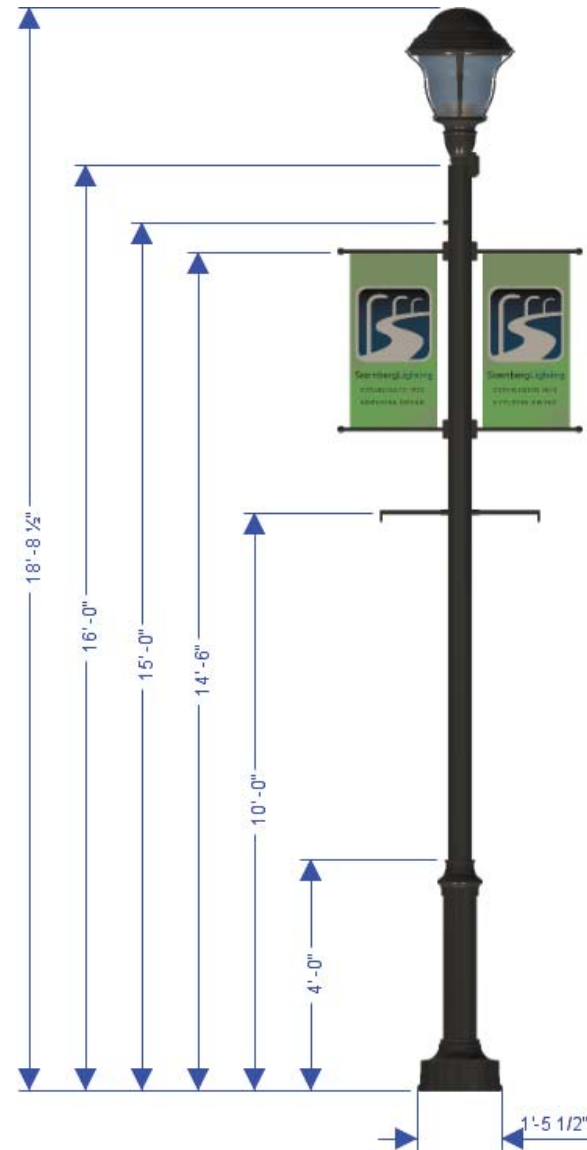
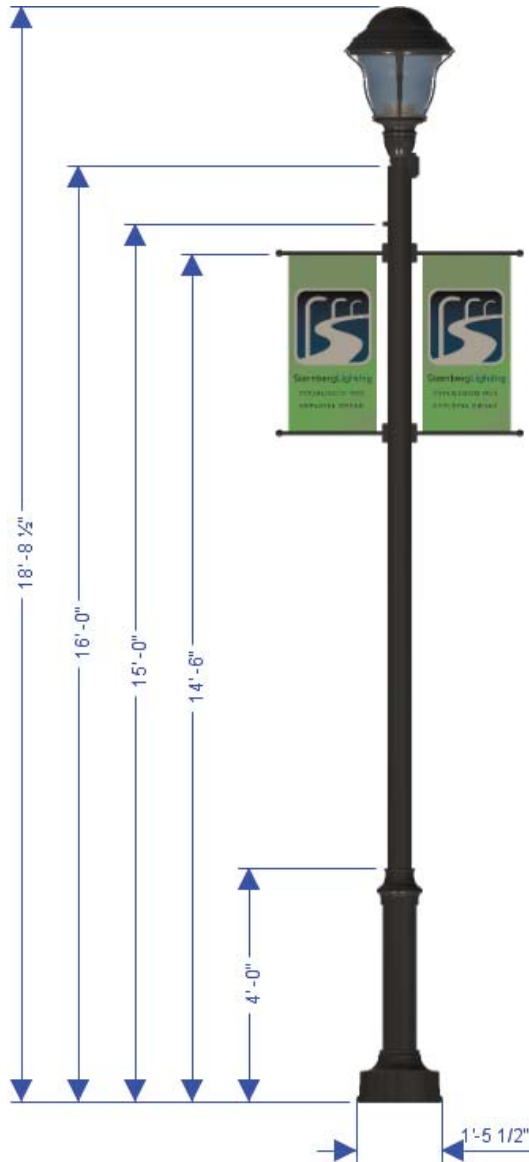

- Accessory Options:**
- Banner arms
 - Electrical outlet
 - Hanging flower baskets
 - Speaker hub

Lighting

Auburn Streetscape - 90% Progress Meeting

June 14, 2017

© 2017 JPR - All Rights Reserved



JONES PETRIE RAFINSKI
 your one single source
 Surveying • Engineering • Planning • Architecture • Utility Management
 GIS • Environmental • Renewable Energy • Landscape Architecture

SIGN POST



ACP SIGN POST

UNILOCK PAVERS



UNILOCK HOLLANDSTONE



UNILOCK IL CAMPO



RUSTIC RED (ENDURACOLOR FINISH)

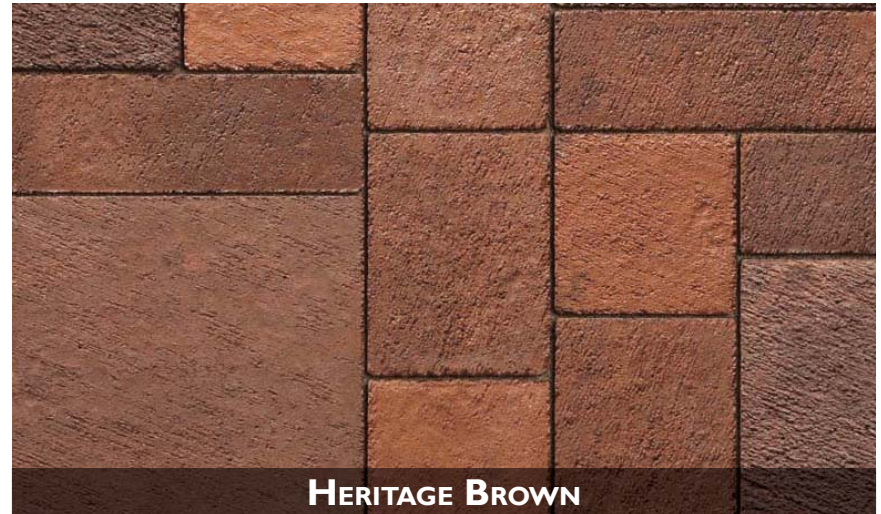

HERITAGE BROWN

Pavers

Auburn Streetscape - 90% Progress Meeting

June 14, 2017

© 2017 JPR - All Rights Reserved



JONES PETRIE RAFINSKI
your one single source

Surveying • Engineering • Planning • Architecture • Utility Management
GIS • Environmental • Renewable Energy • Landscape Architecture



Trash Receptacle

Auburn Streetscape - 90% Progress Meeting

June 14, 2017

© 2017 JPR - All Rights Reserved



JONES PETRIE RAFINSKI
your one single source
Surveying • Engineering • Planning • Architecture • Utility Management
GIS • Environmental • Renewable Energy • Landscape Architecture



Tree Grate

- 5' x 5'
- Powder Coated Black

Tree Grate

Auburn Streetscape - 90% Progress Meeting

June 14, 2017

© 2017 JPR - All Rights Reserved



JONES PETRIE RAFINSKI
your one single source
Surveying • Engineering • Planning • Architecture • Utility Management
GIS • Environmental • Renewable Energy • Landscape Architecture

CONCRETE CURBED PLANTER IDEAS



Planter Ideas

Auburn Streetscape - 90% Progress Meeting

June 14, 2017

© 2017 JPR - All Rights Reserved



JONES PETRIE RAFINSKI
your one single source
Surveying • Engineering • Planning • Architecture • Utility Management
GIS • Environmental • Renewable Energy • Landscape Architecture

ZELKOVA



IVORY SILK LILAC TREE



Trees

Auburn Streetscape - 90% Progress Meeting

June 14, 2017

© 2017 JPR - All Rights Reserved



JONES PETRIE RAFINSKI
your one single source

Surveying • Engineering • Planning • Architecture • Utility Management
GIS • Environmental • Renewable Energy • Landscape Architecture

SHRUBS



GRASSES



PERENNIALS



Shrubs, Grasses, Perennials

Auburn Streetscape - 90% Progress Meeting

June 14, 2017

© 2017 JPR - All Rights Reserved



JONES PETRIE RAFINSKI
your one single source

Surveying • Engineering • Planning • Architecture • Utility Management
GIS • Environmental • Renewable Energy • Landscape Architecture

MAD ANTHONY DUMPSTER ENCLOSURE RENDERING

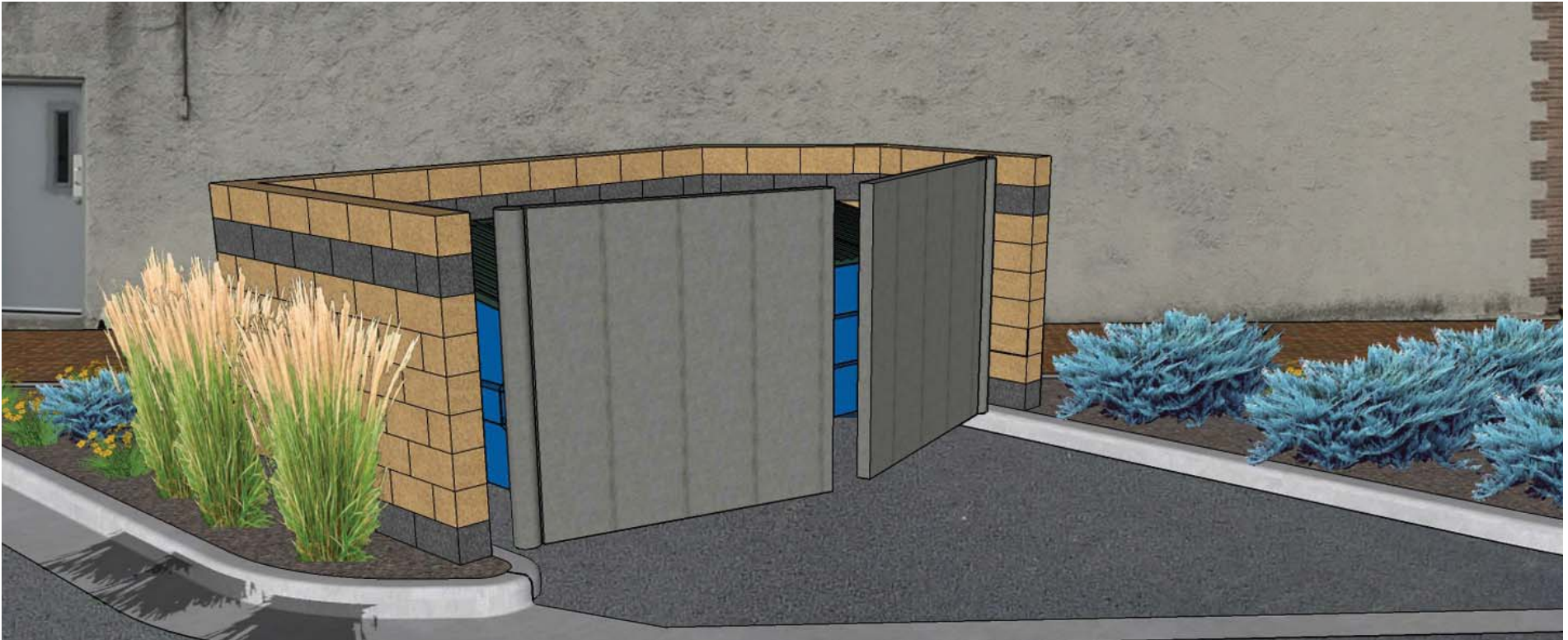

Dumpster Enclosure

- 6' Tall Wall
- Split Face Block Wall (See Above)
- SimTek Vinyl Fence (See Left)



Dumpster Enclosure

Auburn Streetscape - 90% Progress Meeting

June 14, 2017

© 2017 JPR - All Rights Reserved



JONES PETRIE RAFINSKI
your one single source
Surveying • Engineering • Planning • Architecture • Utility Management
GIS • Environmental • Renewable Energy • Landscape Architecture

EXISTING HISTORICAL PLAQUE

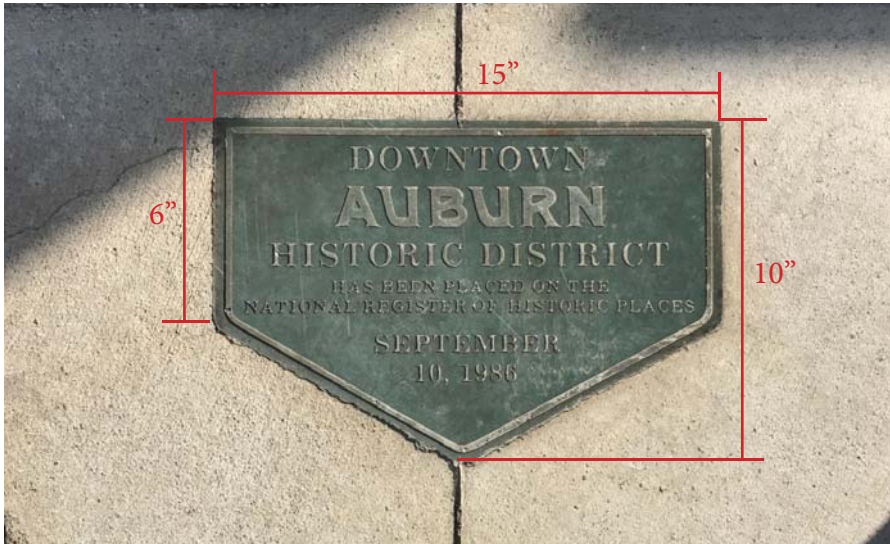

CONCEPTUAL RENDERINGS

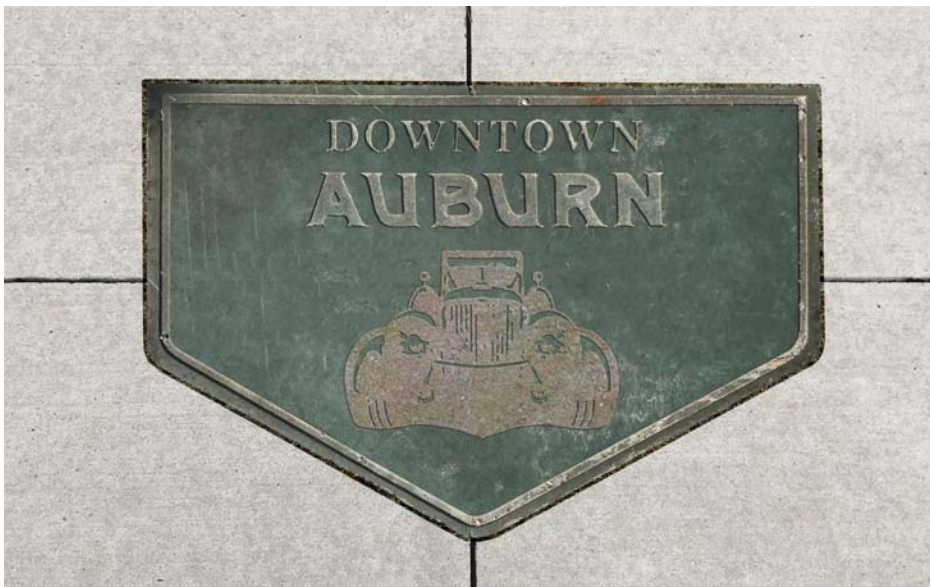
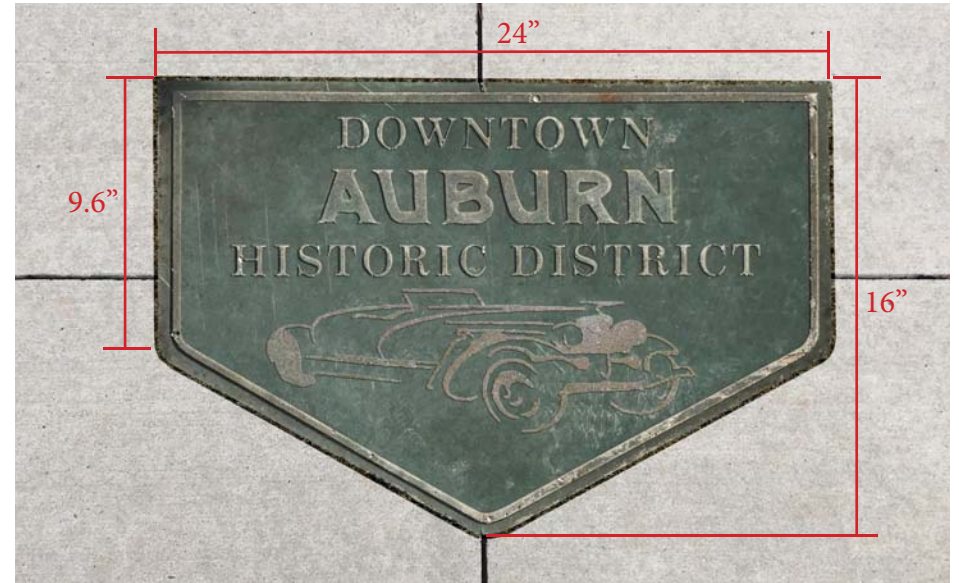

Historical Plaque Concepts

Auburn Streetscape - 90% Progress Meeting

June 14, 2017

© 2017 JPR - All Rights Reserved



JONES PETRIE RAFINSKI
your one single source

Surveying • Engineering • Planning • Architecture • Utility Management
GIS • Environmental • Renewable Energy • Landscape Architecture

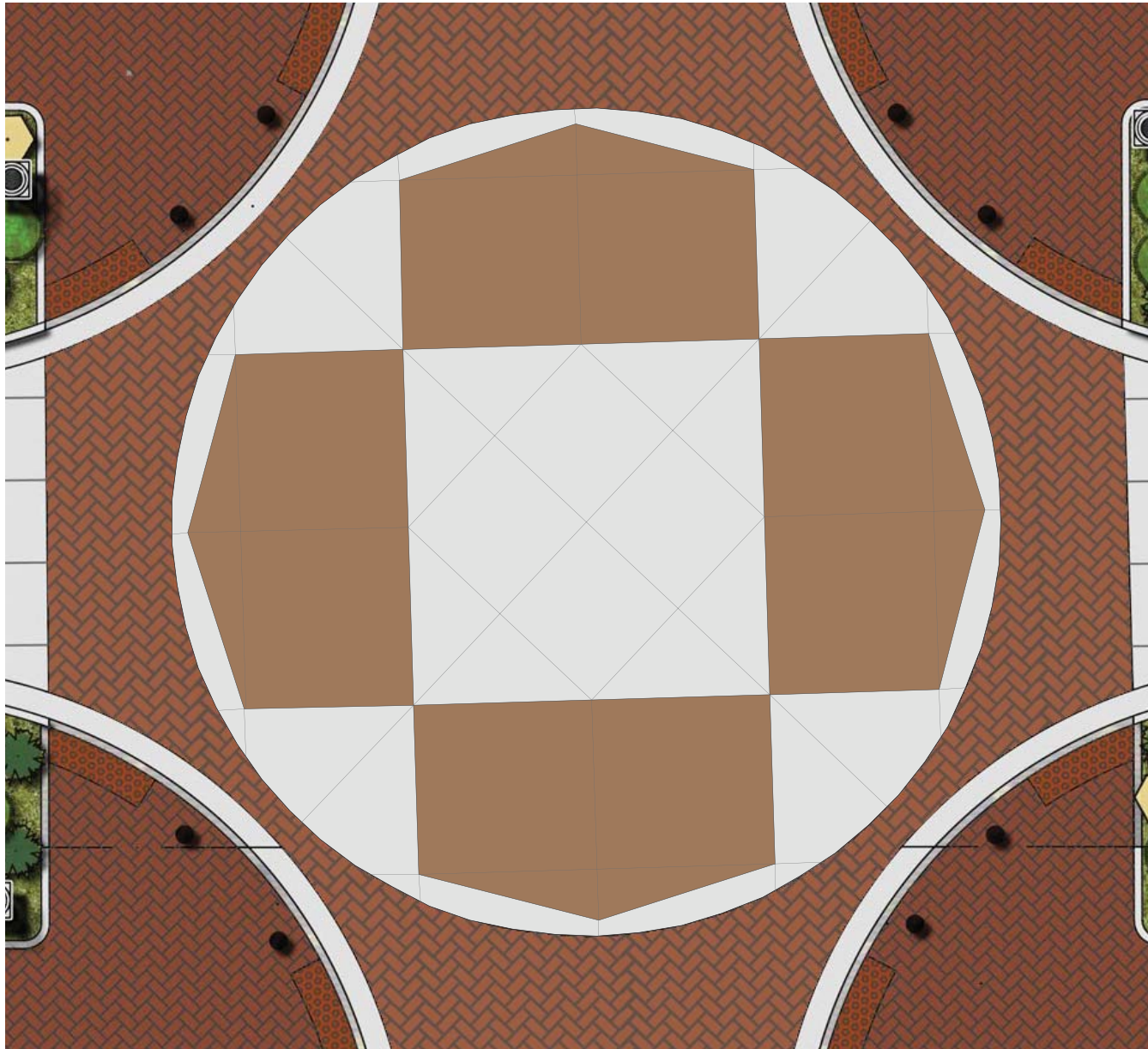

Center Circle Concept

Auburn Streetscape - 90% Progress Meeting

June 14, 2017

© 2017 JPR - All Rights Reserved



JONES PETRIE RAFINSKI
your one single source
Surveying • Engineering • Planning • Architecture • Utility Management
GIS • Environmental • Renewable Energy • Landscape Architecture